



BOSCH



Induction hob with integrated ventilation system

PVQ...F1..

[en] Instruction manual

Hob

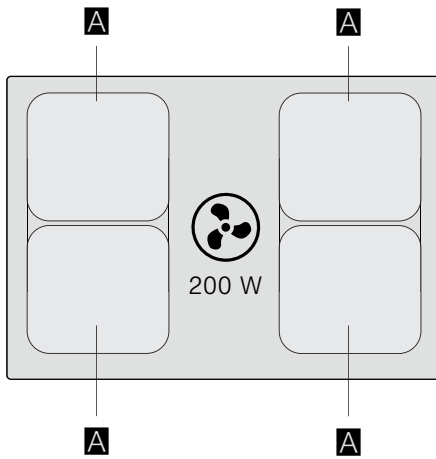

			g*	b*
A	∅ 21		2.200 W	3.700 W
	21 x 38		3.600 W	

* IEC 60335-2-6

Table of contents

	Intended use	4		PowerBoost function	19
	Important safety information	5		Activating	19
	Causes of damage	7		Deactivation	19
	Environmental protection	7		Childproof lock	20
	Energy saving tips	7		Activating and deactivating the childproof lock	20
	Environmentally-friendly disposal	7		Childproof lock	20
	Induction cooking	8		Wipe protection	20
	Advantages of induction cooking	8		Automatic safety cut-out	20
	Cookware	8		Basic settings	21
	Getting to know your appliance	9		To access the basic settings:	22
	Your new appliance	9		Energy consumption indicator	23
	Special accessories	9		Cookware check	23
	The control panel	10		Power manager	24
	The hotplates	11		Cleaning	24
	Residual heat indicator	11		Cleaning agents	24
	Operating modes	12		Components to clean	25
	Exhaust air mode	12		Hob surround (only on appliances with hob surrounds). 25	25
	Circulating-air mode	12		Hob	25
	Before using for the first time	12		Ventilation system	26
	Setting the operating mode	12		Cleaning the overflow container	27
	Operating the appliance	13		Frequently Asked Questions (FAQ)	28
	Switching the hob on and off	13		Trouble shooting	30
	Setting a hotplate	13		Customer service	31
	Chef's recommendations	14		Product number (E no.) and production number (FD no.)	31
	Manual hood control	16		Test dishes	32
	Intensive setting	16			
	Automatic start	16			
	Run-on function	16			
	CombiZone function	17			
	Notes regarding cookware	17			
	Activation	17			
	Deactivating	17			
	Move function	17			
	Advice on using cookware	17			
	Activation	18			
	Deactivation	18			
	Time-setting options	18			
	Programming the cooking time	18			
	The kitchen timer	19			

Additional information on products, accessories and services can be found at **bosch** and in the online shop **banyo.co.uk**

Intended use

Read these instructions carefully. Please keep the instruction and installation manual, as well as the appliance certificate, in a safe place for later use or for subsequent owners.

Check the appliance after removing it from the packaging. If it has suffered any damage in transport, do not connect the appliance, contact the Technical Assistance Service and provide written notification of the damage caused, otherwise you will lose your right to any type of compensation.

Only a licensed professional may connect appliances without plugs. Damage caused by incorrect connection is not covered under warranty.

This appliance must be installed according to the installation instructions included.

This appliance is intended for private domestic use and the household environment only. The appliance must only be used for the preparation of food and beverages. The cooking process must be supervised. A short cooking process must be supervised without interruption. Only use the appliance in enclosed spaces.

This appliance is intended for use up to a maximum height of 2000 metres above sea level.

Do not use covers. These can cause accidents, for example due to overheating, catching fire or materials shattering.

Only use safety devices or child protection grilles approved by ourselves. Unsuitable safety devices or child protection grilles may result in accidents.

This appliance is not intended for operation with an external clock timer or a remote control.

Dangerous or explosive materials and vapours must not be extracted.

Ensure that no small parts or liquids get into the appliance.

This appliance may be used by children over the age of 8 years old and by persons with reduced physical, sensory or mental capabilities or by persons with a lack of experience or knowledge if they are supervised or are instructed by a person responsible for their safety how to use the

appliance safely and have understood the associated hazards.

Children must not play with, on, or around the appliance. Children must not clean the appliance or carry out general maintenance unless they are at least 15 years old and are being supervised.

Keep children below the age of 8 years old at a safe distance from the appliance and power cable.

If you wear an active implantable medical device (e.g. a pacemaker or defibrillator), check with your doctor that it complies with Council Directive 90/385/EEC of 20th June 1990, DIN EN 45502-2-1 and DIN EN 45502-2-2, and that it has been chosen, implanted and programmed in accordance with VDE-AR-E 2750-10. If these conditions are satisfied, and if, in addition, non-metal cooking utensils and cookware with non-metal handles are used, it is safe to use this induction hob as intended.

Important safety information

Warning – Danger of suffocation!

Packaging material is dangerous to children. Never allow children to play with packaging material.

Warning – Danger of death!

Risk of poisoning from flue gases being drawn back in.

Always ensure that there is an adequate supply of fresh air to the room if the appliance is being operated in air extraction mode at the same time as a non-room-sealed heating appliance is being operated.

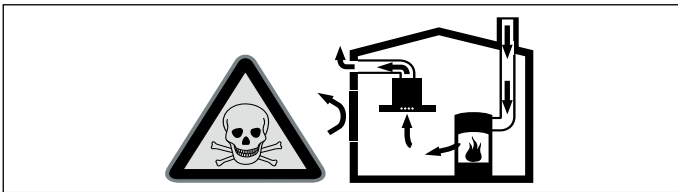

Non-room-sealed heating appliances (e.g. gas-, oil-, wood- or coal-burning heaters, continuous flow heaters or water heaters) draw in combustion air from the room in which they are installed and discharge the exhaust gases outdoors through an exhaust gas system (e.g. a chimney).

With the extractor hood switched on, air is extracted from the kitchen and the adjacent rooms – without an adequate supply of air, the air pressure falls below atmospheric pressure. Toxic gases from the chimney or the extraction shaft are sucked backed into the living space.

- There must therefore always be an adequate supply of air.
- A supply-air/air-extraction duct alone is not sufficient to ensure compliance with the limit.

It is only possible to safely operate the appliance if the pressure in the room in which the heating appliance is installed does not drop more than 4 Pa (0.04 mbar) below atmospheric pressure. This can be achieved if the air needed for combustion is able to enter through openings that cannot be sealed, for example through doors, windows, by means of a supply-air/air-extraction duct or by other technical means.

The exhaust air must not be conveyed into a functioning smoke or exhaust gas flue or into a shaft that is used to ventilate rooms in which heating appliances are installed.

If the exhaust air is to be conveyed into a non-functioning smoke or exhaust gas flue, you must obtain the consent of the heating engineer responsible.

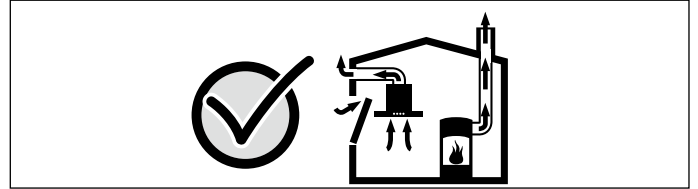

Always consult the heating engineer responsible. They will be able to assess the house's entire ventilation setup and suggest the most appropriate ventilation measures. Unrestricted operation is possible if the extractor hood is operated exclusively in air recirculation mode.

Warning – Risk of fire!

- Hot oil and fat can ignite very quickly. Never leave hot fat or oil unattended. Never use water to put out burning oil or fat. Switch off the hotplate. Extinguish flames carefully using a lid, fire blanket or something similar.
- The hotplates become very hot. Never place combustible items on the hob. Never place objects on the hob.
- The appliance gets hot. Do not keep combustible objects or aerosol cans in drawers directly underneath the hob.
- The hob switches off automatically and can no longer be operated. It may switch on unintentionally at a later point. Switch off the circuit breaker in the fuse box. Contact the after-sales service.
- Fatty deposits in the grease filter may catch fire. Regularly clean the grease filter. Never operate the appliance without a grease filter.
- When the ventilation system is switched on, fatty deposits in the grease filter may catch fire. Never work with naked flames close to the appliance (e.g. flambéing). Do not install the appliance near a solid fuel heating appliance (e.g. wood- or coal-burning) unless a sealed, non-removable cover is fitted. There must be no flying sparks.

⚠ Warning – Risk of burns!

- The hotplates and surrounding area (particularly the hob surround, if fitted) become very hot. Never touch the hot surfaces. Keep children at a safe distance.
- The hotplate heats up but the display does not work. Switch off the circuit breaker in the fuse box. Contact the after-sales service.
- Metal objects on the hob quickly become very hot. Never place metal objects (such as knives, forks, spoons and lids) on the hob.
- After each use, always turn off the hob at the main switch. Do not wait until the hob turns off automatically after the pan is removed.
- The accessible parts become very hot when in operation. Never touch hot parts. Keep children at a safe distance.
- The appliance becomes hot during operation. If hot liquids penetrate the appliance, leave the appliance to cool before removing the metal grease filter or the overflow container.

⚠ Warning – Risk of electric shock!

- Incorrect repairs are dangerous. Repairs may only be carried out and damaged power cables replaced by one of our trained after-sales technicians. If the appliance is defective, unplug the appliance from the mains or switch off the circuit breaker in the fuse box. Contact the after-sales service.
- Do not use any high-pressure cleaners or steam cleaners, which can result in an electric shock.
- A defective appliance may cause electric shock. Never switch on a defective appliance. Unplug the appliance from the mains or switch off the circuit breaker in the fuse box. Contact the after-sales service.
- Cracks or fractures in the glass ceramic may cause electric shocks. Switch off the circuit breaker in the fuse box. Contact the after-sales service.

⚠ Warning – Risk of injury!

- When cooking in a bain marie, the hob and cooking container could shatter due to overheating. The cooking container in the bain marie must not directly touch the bottom of the water-filled pot. Only use heat-resistant cookware.
- Saucepans may suddenly jump due to liquid between the pan base and the hotplate. Always keep the hotplate and saucepan bases dry.

Causes of damage

Caution!

- Rough pan bases may scratch the hob.
- Objects that are hard or sharp may damage the hob. Do not allow hard or sharp objects to fall on the hob.
- Heating cookware when empty may cause surface damage. Never leave empty cookware on the heat.
- Do not place hot pans on the control panel, the indicator area, or the hob frame. Doing so may cause damage.
- Never leave aluminium foil or plastic containers on hot hotplates as this may damage the hob. Do not use oven liners.
- Using unsuitable cleaning products may cause surface damage, discolouration and stains. Only use cleaning products that are suitable for this type of hob.
- Friction from pots and pans may cause surface damage and discolouration. Always lift pots and pans up before repositioning them; do not slide them across the surface of the hob.
- Burnt-on food may cause surface damage and staining. Immediately remove any food that has boiled over using a glass scraper.
- Salt, sugar and sand may cause surface damage. Do not use the hob as a work surface or storage space.
- Using cookware with a rough base may cause surface damage. Check all cookware before use.
- Sugar and foods with a high sugar content may cause surface damage or conchoidal fracturing. Immediately remove any food that has boiled over using a glass scraper.

Environmental protection

In this section, you can find information about saving energy and disposing of the appliance.

Energy saving tips

- Always use a matching lid for every item of cookware. Cooking without a lid consumes significantly more energy. Use a glass lid. Then you can see into the pan without raising the lid.
- Use cookware with a flat base. Uneven bases increase the energy consumption.
- Make sure that the diameter of the cookware base corresponds to the size of the cooking zone. Please note: Cookware manufacturers often specify the diameter of the top of the pan, which is usually larger than the diameter of the base of the pan.
- For small quantities, use small items of cookware. Using cookware that is large but barely filled requires a lot of energy.
- Cook with as little water as possible. This saves energy and preserves the vitamins and minerals in vegetables.
- Switch to a lower heat setting in good time. This prevents energy from being wasted.
- During cooking, ensure that there is a sufficient supply of air to enable the ventilation system to work efficiently and with a low level of operating noise.
- Adjust the fan speed to the amount of cooking vapour produced during cooking. Only use the intensive setting if needed. A lower fan speed consumes less energy.
- If cooking produces large amounts of vapour, select a higher fan speed in good time. If the cooking vapour has already spread around the kitchen, the ventilation system will need to be operated for longer.
- Switch the appliance off when you are not using it.
- Clean and (if required) replace the filter at regular intervals in order to increase the effectiveness of the ventilation system and to prevent the risk of fire.

Environmentally-friendly disposal

Dispose of packaging in an environmentally-friendly manner.



This appliance is labelled in accordance with European Directive 2012/19/EU concerning used electrical and electronic appliances (waste electrical and electronic equipment - WEEE). The guideline determines the framework for the return and recycling of used appliances as applicable throughout the EU.

Induction cooking

Advantages of induction cooking

Induction cooking is very different from traditional cooking methods, as heat builds up directly in the item of cookware. This offers numerous advantages:

- Saves time when boiling and frying.
- Saves energy.
- Easier to care for and clean. Spilled food does not burn on as quickly.
- Heat control and safety – the hob increases or decreases the heat supply as soon as the user changes the setting. The induction hotplate stops the heat supply as soon as the cookware is removed from the hotplate, without having to switch it off first.

Cookware

Only use ferromagnetic cookware for induction cooking, such as:

- Cookware made from enamelled steel
- Cookware made from cast iron
- Special induction-compatible cookware made from stainless steel.

To check whether your cookware is suitable for induction cooking, refer to the section on → "Cookware check".

To achieve a good cooking result, the ferromagnetic area on the base of the pan should match the size of the hotplate. If a hotplate does not detect an item of cookware, try placing it on another hotplate with a smaller diameter.

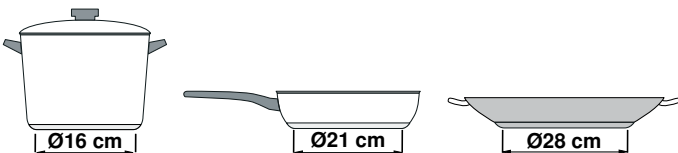

Some induction cookware does not have a fully ferromagnetic base:

- If the base of the cookware is only partially ferromagnetic, only the area that is ferromagnetic will heat up. This may mean that heat will not be distributed evenly. The non-ferromagnetic area may not heat up to a sufficient temperature for cooking.

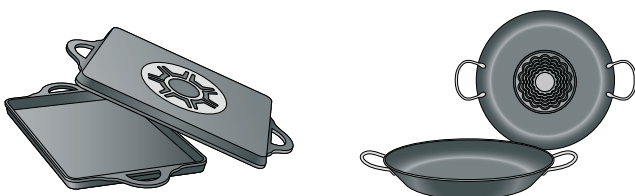

- The ferromagnetic area will also be reduced if the material from which the base of the cookware is made contains aluminium, for example. This may mean that the cookware will not become sufficiently hot or even that it will not be detected.

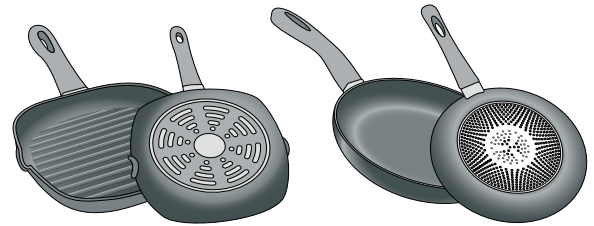

Unsuitable pans

Never use diffuser hobs or pans made from:

- common thin steel
- glass
- earthenware
- copper
- aluminium

Properties of the base of the cookware

The material(s) from which the base of the cookware is made can affect the cooking result. Using pots and pans made from materials that distribute heat evenly through them, such as stainless-steel pans with a three-layer base, saves time and energy.

Use cookware with a flat base; if the base of the cookware is uneven, this may impair the heat supply.

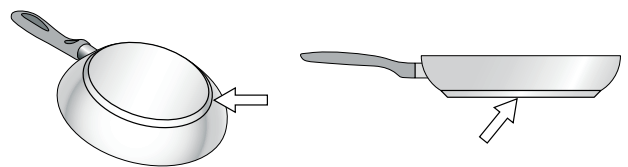

Absence of pan or unsuitable size

If no pan is placed on the selected hotplate, or if it is made of unsuitable material or is not the correct size, the power level displayed on the hotplate indicator will flash. Place a suitable pan on the hotplate to stop the flashing. If this takes more than 90 seconds, the hotplate will switch off automatically.

Empty pans or those with a thin base

Do not heat empty pans, nor use pans with a thin base. The hob is equipped with an internal safety system. However, an empty pan may heat up so quickly that the "automatic switch off" function may not have time to react and the pan may reach very high temperatures. The base of the pan could melt and damage the glass on the hob. In this case, do not touch the pan and switch the hotplate off. If it fails to work after it has cooled down, please contact the Technical Assistance Service.

Pan detection

Each hotplate has a lower limit for pan detection. This depends on the diameter of the ferromagnetic area of the cookware and the material from which its base is made. For this reason, you should always use the hotplate that best matches the diameter of the base of the pan.

Getting to know your appliance

You can find information on the dimensions and power of the hotplates in → *Page 2*

Note: Depending on the appliance model, individual details and colours may differ.

Your new appliance

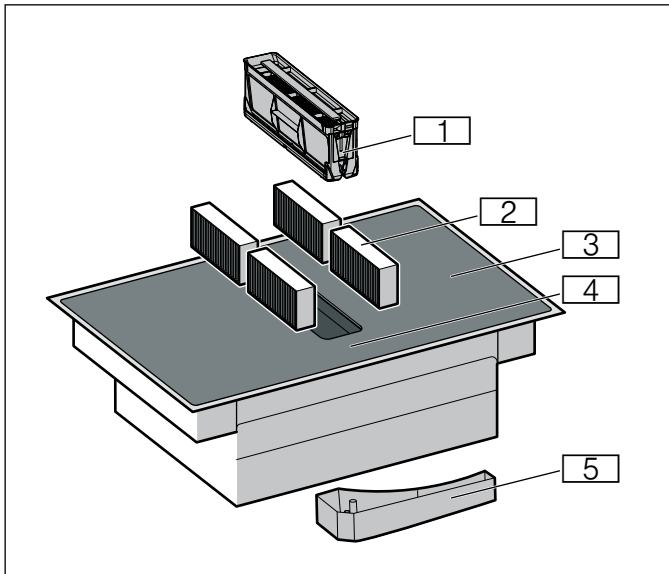

No.	Designation
1	Metal grease filter
2	Activated charcoal filter for air recirculation or acoustics filter for air extraction*
3	Hob
4	Control panel
5	Overflow container

*Depending on the appliance specifications

Special accessories

Depending on the appliance model, various accessories are available and you can obtain these from specialist retailers, from our after-sales service or from our official website:

- Air extraction set
- Air recirculation set
- Activated charcoal filter: For air circulation
- Acoustics filter: For air extraction mode

The control panel

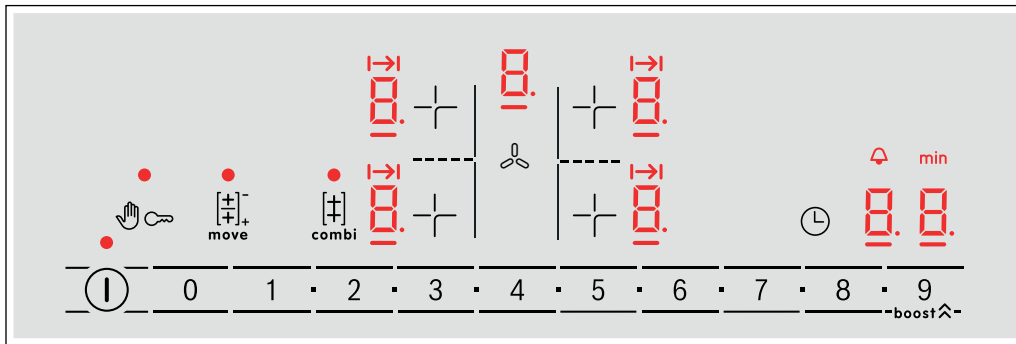

Selection sensors	
ⓘ	Main switch
+	Selecting the cooking zone
0 1 2 ... 8 9	Settings area
👤🔑	Locking the control panel for cleaning
🔑	Childproof lock
combi	CombiZone function
move	Move function
boost ⬆	PowerBoost functions Intensive ventilation settings
🕒	Time-setting options
👉	Manual hood control

Display	
0	Operating status
1-9	Power levels
00	Timer function
H/h	Residual heat
b	PowerBoost function Intensive ventilation setting I
b.	Intensive ventilation setting II
I→I	Cooking timer
🕒	Timer
min	Time indicator

Touch controls



Touching a symbol activates the associated function.

Notes

- Always keep the control panel clean and dry. Moisture reduces its effectiveness.
- Do not place any cookware near the indicators or sensors. The electronics could overheat.

The hotplates

Cooking zones

	Single cooking zone	Use cookware that is a suitable size
	Combined cooking zone	See the section entitled → "CombiZone function" or → "Move function"

Only use cookware that is suitable for induction cooking; see the section entitled → "Induction cooking"

Residual heat indicator

The hob has a residual heat indicator for each hotplate. This indicates that a hotplate is still hot. Do not touch a hotplate while the residual heat indicator is lit up.

The following indicators are shown depending on the amount of residual heat:

- Display **H**: High temperature
- Display **h**: Low temperature

If you remove the cookware from the hotplate during cooking, the residual heat indicator and the selected heat setting will flash alternately.

When the hotplate is switched off, the residual heat indicator will light up. Even after the hob has been switched off, the residual heat indicator will stay lit for as long as the hotplate is still warm.

Operating modes

This appliance can be used in air extraction mode or circulating-air mode.

Exhaust air mode



The air which is drawn in is cleaned by the grease filters and conveyed to the exterior by a pipe system.

Note: The exhaust air must not be conveyed into a functioning smoke or exhaust gas flue or into a shaft which is used to ventilate installation rooms which contain heat-producing appliances.

- Before conveying the exhaust air into a non-functioning smoke or exhaust gas flue, obtain the consent of the heating engineer responsible.
- If the exhaust air is conveyed through the outer wall, a telescopic wall box should be used.

Circulating-air mode



The air which is drawn in is cleaned by the grease filters and an activated carbon filter and conveyed back into the kitchen.

Note: To bind odours in circulating-air mode, you must install an activated carbon filter. The different options for operating the appliance in circulating-air mode can be found in the brochure. Alternatively, ask your dealer. The required accessories are available from specialist outlets, from customer service or from the Online Shop.

Before using for the first time

Please read the following information before using the appliance for the first time:

Clean the appliance and all accessory parts thoroughly.

Before you can use your new appliance, you must apply certain settings.

Switch the hob on and off using the main switch .

Setting the operating mode

The appliance is supplied with a preset air recirculation mode.

When the hob is installed with an air outlet to the outside, you must configure the setting  17 in this mode. See section → "Basic settings".

Operating the appliance



This chapter explains how to set a hotplate. The table shows heat settings and cooking times for various meals.

Tip: Switch on the ventilation system when you start cooking and only switch it off a few minutes after you have finished cooking. This is the most effective way to remove the cooking vapours.

Note: Never operate the appliance without the metal grease filter and the overflow container.

Switching the hob on and off

The main switch is used to switch the hob on and off.

To switch on: Touch the  symbol. An audible signal sounds. The indicator next to the main switch and the hotplate indicators  light up. The hob is ready to use.

To switch off: Touch the  symbol until the indicator goes out. All hotplates are switched off. The residual heat indicator remains lit until the hotplates have cooled down sufficiently.

Notes

- The hob switches off automatically if all hotplates have been switched off for more than 20 seconds.
- The selected settings are stored for four seconds after the hob has been switched off. If you switch it on again during this time, the hob will operate using the previously stored settings.

Setting a hotplate

Set the required heat setting using symbols **1** to **9**.

Heat setting **1** = lowest setting.

Heat setting **9** = highest setting.



Every heat setting has an intermediate setting. This intermediate setting is marked in the control panel with the  symbol.

Notes

- To protect the fragile parts of your appliance from overheating and electrical overloading, the hob may temporarily reduce the power.
- In order to prevent the appliance from producing excess noise, the hob may temporarily reduce the power.

Selecting a hotplate and heat setting

The hob must be switched on.

1. Touch the  symbol for the required hotplate. The  symbol lights up and the  symbol underneath.
2. Then select the required heat setting from the settings range.

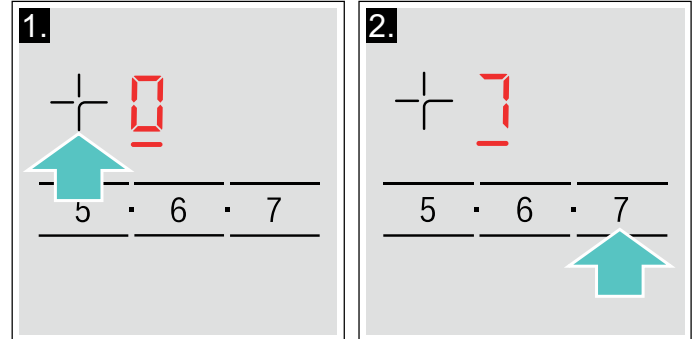

The heat setting is set.

Changing the heat setting

Select the hotplate and then set the required heat setting in the control panel.

Switch off the hotplate

Select the hotplate and set it to  in the programming panel. The hotplate turns off and the residual heat indicator appears.

Notes

- If no pan has been placed on the hotplate, the selected power level flashes. After a certain time has elapsed, the hotplate switches off.
- If a pan has been placed on the hotplate before switching on the hob, it will be detected within 20 seconds of pressing the main switch and the hotplate will be selected automatically. Once detected, select the power level within the next 20 seconds or the hotplate will switch off. If more than one pan is placed on the hob, only one will be detected when switching it on.

Chef's recommendations

Recommendations

- When heating up puree, cream soups and thick sauces, stir occasionally.
- Set heat setting 8 to 9 for preheating.
- When cooking with the lid on, turn the heat setting down as soon as steam escapes between the lid and the cookware. Steam does not need to escape for a good cooking result.
- After cooking, keep the lid on the cookware until you serve the food.
- To cook with the pressure cooker, observe the manufacturer's instructions.
- Do not cook food for too long, otherwise the nutrients will be lost. The kitchen clock can be used to set the optimum cooking time.
- For a more healthy cooking result, smoking oil should be avoided.
- To brown food, fry small portions in succession.
- Cookware may reach high temperatures while the food is cooking. We recommend that you use oven gloves.
- You can find recommendations for energy-efficient cooking in section → *"Environmental protection"*

Cooking table

The table shows which heat setting is suitable for each type of food. The cooking time may vary depending on the type, weight, thickness and quality of the food.

	Heat setting	Cooking time (mins)
Melting		
Chocolate coating	1 - 1.	-
Butter, honey, gelatine	1 - 2	-
Heating and keeping warm		
Stew, e.g. lentil stew	1. - 2	-
Milk*	1. - 2.	-
Heating sausages in water*	3 - 4	-
Defrosting and heating		
Spinach, frozen	3 - 4	15 - 25
Goulash, frozen	3 - 4	35 - 55
Poaching, simmering		
Potato dumplings*	4. - 5.	20 - 30
Fish*	4 - 5	10 - 15
White sauces, e.g. Béchamel sauce	1 - 2	3 - 6
Whisked sauces, e.g. sauce béarnaise, hollandaise	3 - 4	8 - 12

* Without lid

** Turn several times

*** Preheat to heat setting 8 - 8.

	Heat setting	Cooking time (mins)
Boiling, steaming, braising		
Rice (with double the volume of water)	2.-3.	15-30
Rice pudding***	2-3	30-40
Unpeeled boiled potatoes	4.-5.	25-35
Boiled potatoes	4.-5.	15-30
Pasta, noodles*	6-7	6-10
Stew	3.-4.	120-180
Soups	3.-4.	15-60
Vegetables	2.-3.	10-20
Vegetables, frozen	3.-4.	7-20
Cooking in a pressure cooker	4.-5.	-
Braising		
Roulades	4-5	50-65
Pot roast	4-5	60-100
Goulash***	3-4	50-60
Roasting/frying with little oil*		
Escalope, plain or breaded	6-7	6-10
Escalope, frozen	6-7	6-12
Chop, plain or breaded**	6-7	8-12
Steak (3 cm thick)	7-8	8-12
Poultry breast (2 cm thick)**	5-6	10-20
Poultry breast, frozen**	5-6	10-30
Rissoles (3 cm thick)**	4.-5.	20-30
Hamburgers (2 cm thick)**	6-7	10-20
Fish and fish fillet, plain	5-6	8-20
Fish and fish fillet, breaded	6-7	8-20
Fish, breaded and frozen, e.g. fish fingers	6-7	8-15
Scampi, prawns	7-8	4-10
Sautéing fresh vegetables and mushrooms	7-8	10-20
Stir-fry, vegetables, meat cut in Asian-style strips	7-8	15-20
Frozen dishes, e.g. roasted dishes	6-7	6-10
Pancakes (baked in succession)	6.-7.	-
Omelette (cooked in succession)	3.-4.	3-10
Fried eggs	5-6	3-6
Deep-fat frying* (150-200 g per portion in 1-2 l oil, deep-fat fried in portions)		
Frozen products, e.g. chips, chicken nuggets	8-9	-
Croquettes, frozen	7-8	-
Meat, e.g. chicken portions	6-7	-
Fish, breaded or in beer batter	6-7	-
Vegetables, mushrooms, breaded or battered, tempura	6-7	-
Small baked items, e.g. doughnuts, fruit in batter	4-5	-

* Without lid

** Turn several times



*** Preheat to heat setting 8-8.

Manual hood control



You can control the ventilation setting manually.

Note: Using tall items of cookware may prevent the extraction system from working at optimum power. The extraction power can be improved by placing a lid on the cookware at an angle.

Activation

1. Touch the  symbol.
The ventilation system starts at the preset power level.
2. Within the next 10 seconds, select the required power level in the settings area.
The selected power level lights up.
3. Touch the  symbol to confirm the selected setting.
The ventilation system switched on.

Changing and switching off





Touch the  symbol and select the required power level or set it to  in the settings area.

Intensive setting

There are two intensive modes for the ventilation system. If you activate the intensive settings, the ventilation system works at maximum output for a short time.



Activation

Touch the  symbol and select the required intensive setting.

- **Intensive setting I** : Select the power level  and then touch the **Boost**  symbol. The  display lights up. The intensive setting is activated.
- **Intensive setting II** : Touch the **Boost**  symbol again. The  display lights up. The intensive setting is activated.

Note: After eight minutes, the appliance automatically switches back to fan setting .

Changing and switching off

Touch the  symbol and select the required power level or set it to  in the settings area.

Automatic start

If you select a power level for a cooking zone, the automatic start switches on. The ventilation system switches on at a power level in accordance with the respective power level for the cooking zones.

You can find out how to change this setting in section → "Basic settings".

Run-on function

The run-on function allows the ventilation system to continue operating for a few minutes after the hob has been switched off. This removes any remaining cooking vapours. The ventilation system then automatically switches off.

Activation

As standard, the run-on time is activated with a maximum switch-off time. You can find out how to change this setting in section → "Basic settings".

Note: The run-on function only switches on if at least one cooking zone has been switched on for at least one minute.

Deactivating

Manual

Touch the  symbol. The run-on function is switched off.

Automatic

The run-on function is switched off in the following cases:

- The run-on time has elapsed.
- The appliance is switched on again.

CombiZone function

You can use this function to connect the Combi zone and set the same heat setting for both cooking zones. This is especially suitable for cooking with oblong cookware.

Notes regarding cookware

For best results, use cookware that matches the size of the two cooking zones. Place the cookware in the centre of the cooking zones.

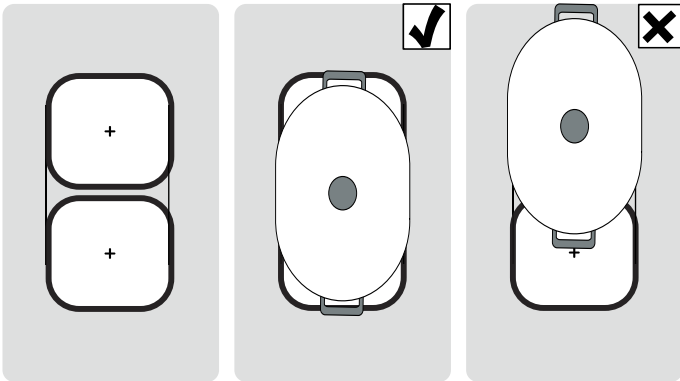

If you are using only one piece of cookware on one of the two cooking zones, you can move it to the second cooking zone. If you do this, the heat setting and the selected settings are transferred.

Activation

The hob must be switched on.

1. Select one of the two hotplates which are included in the combi zone and set the heat setting.
2. Touch the  symbol. The ● indicator lights up. The heat setting appears in the display for the lower hotplate.

The function is activated.

Changing the heat setting

Select one of the two hotplates in the Combi zone and change the heat setting in the setting range.

Deactivating

Select one of the two hotplates assigned to this function and touch the  symbol.

The function has been deactivated. The two hotplates will now function independently.

Move function

You can use this function to connect the Combi zone and select different heat settings for the two cooking zones. Default heat settings:

Front cooking zone = heat setting **9**

Rear cooking zone = heat setting **1**.

The heat settings for each cooking zone can be changed independently of one another.

Notes

- Only place cookware on one of the hotplates. The function will not be activated if there is cookware on each of the two hotplates.
- The heat setting is less brightly lit on the display for the hotplate on which there is no cookware. It will not be activated until the cookware is moved to this hotplate and is detected.
- If the function has already been activated and a second piece of cookware is placed on the free hotplate, the display lights up less brightly, as before. The hotplate is not active. The hotplate is activated when the first piece of cookware is removed.

Advice on using cookware

To ensure that the cookware is detected and heat is distributed evenly, correctly centre the cookware:

Only use one piece of cookware that only covers one of the cooking zones.

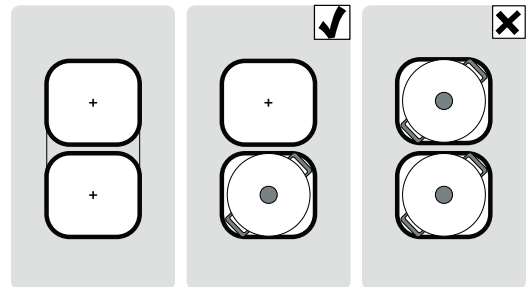

Move the cookware from one cooking zone to another:

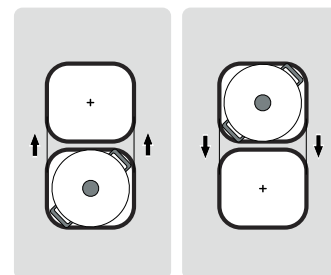

Activation

Combine the two hotplates which each have different heat settings.

1. Select one of the two hotplates which are included in the move function.
2. Touch the  symbol. The ● indicator lights up. The heat settings appear in the displays for the two hotplates.

The function is activated.

Notes

- The display for the hotplate on which the cookware is placed lights up more brightly.
- The  indicator lights up on the display for the hotplate that is still selected.

Changing the heat setting

Select one of the two hotplates which are included in the move function and change the heat setting in the settings range.

Note: If the function is deactivated, the heat settings return to the preset values

Deactivation

Touch the  symbol.

The function is deactivated.

Note: When one of the two hotplates is set to , the function is deactivated within approx. 10 seconds.

Time-setting options



Your hob has two timer functions:

- Programming the cooking time
- Kitchen timer

Programming the cooking time

The hotplate automatically switches off after the time that is set has elapsed.

Setting procedure:

1. Select the hotplate and the required heat setting.
2. Touch the  symbol.  lights up on the display for the hotplate.  lights up on the timer display.
3. Within the next 10 seconds, set the required cooking time in the settings range.

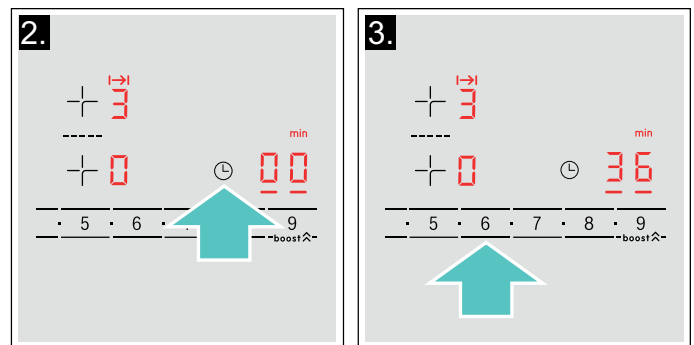



After a few seconds, the time begins to elapse.

Notes

- The same cooking time can be set automatically for all hotplates. The set time for each of the hotplates counts down independently from the others. You can find information on automatically programming the cooking time in section → "Basic settings"
- If the Combi Zone or Move function is selected for the combined hotplate, the set time for both hotplates is the same.

Changing or cancelling the time

Select the hotplate and then press the  symbol.

Change the cooking time using the programming zone or set to  in order to cancel the time.

Once the time has elapsed

The hotplate switches off. A warning signal sounds. The time program function lights up  for 10 seconds in the display.

When the  symbol is pressed, the indications turn off and the beeping stops.

Notes

- To set a cooking time of under 10 minutes, always touch **0** before you select the required value.
- If a cooking time was programmed for several hotplates, the time information for the selected hotplate is shown in the timer display.
- Select the relevant hotplate to call up the remaining cooking time.
- You can set a cooking time of up to **99** minutes.

The kitchen timer

You can use the kitchen timer to set a time of up to 99 minutes.

This functions independently from the hotplates and from other settings. This function does not automatically switch off a hotplate.

Setting

1. Touch the ⌚ symbol repeatedly until the 🔔 indicator lights up. 00 lights up on the timer display.
2. Set the desired time in the settings area. After a few seconds, the time begins to elapse.

Changing or deleting the time

Touch the ⌚ symbol repeatedly until the 🔔 indicator lights up.

Change the time in the settings area or set 00 in order to delete the programmed time.

When the time has elapsed

An audible signal sounds. 00 appears on the timer display and the 🔔 indicator lights up. The displays go out after 10 seconds.

When the ⌚ symbol is touched, the displays go out and the audible signal ceases.

PowerBoost function

The PowerBoost function enables you to heat up large quantities of water faster than when using heat setting 9.

This function can always be activated for a hotplate, provided the other hotplate in the same group is not in use (see illustration). Otherwise, b and 9 will flash in the display for the selected hotplate; the 9 heat setting will then be set automatically without activating the function.

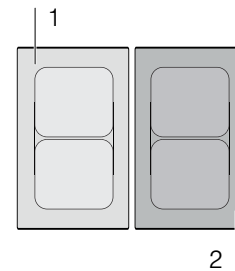

Note: In the Combi zone, the PowerBoost function can only be activated if the two cooking zones are used independently of each other.

Activating

1. Select a hotplate.
2. Select the 9 heat setting and then touch the **boost** symbol. The b indicator lights up. The function was activated.

Deactivation

1. Select the hotplate.
2. Touch the **boost** symbol. b goes out on the display and the hotplate switches back to the 9 heat setting. The function is deactivated.



Note: In certain circumstances, the PowerBoost function can switch itself off automatically in order to protect the electronic elements inside the hob.

Childproof lock

You can use the childproof lock to prevent children from switching on the hob.

Activating and deactivating the childproof lock

The hob must be switched off.

To activate: Touch the  symbol for approx. 4 seconds. The  symbol lights up for 10 seconds. The hob is locked.

To deactivate: Touch the  symbol for approx. 4 seconds. The lock is released.

Childproof lock

With this function, the childproof lock automatically activates when a hob is switched off.

Switching on and off

You can find out how to switch the automatic childproof lock on in the → "Basic settings" section

Wipe protection

If you wipe over the control panel while the hob is switched on, settings may be altered. To avoid doing this, you can use the hob's "Lock control panel for cleaning" function.

To switch on: Touch the  symbol. An audible signal sounds. The control panel is locked for 35 seconds. You can now wipe over the surface of the control panel without altering any settings.

To deactivate: The control panel will be unlocked once 35 seconds have elapsed. To release the function early, touch the  symbol.

Notes

- An audible signal sounds 30 seconds after activation. This indicates that the function is about to finish.
- The cleaning lock does not lock the main switch. The hob can be switched off at any time.

Automatic safety cut-out

If a hotplate operates for an extended period and no settings are changed, the automatic safety shut-off is activated.

The hotplate stops heating. **F**, **B** and the residual heat indicator **h** or **H** flash alternately in the hotplate display.

When you touch any symbol, the display switches off. The hotplate can now be set again.

The point at which the safety shut-off becomes active depends on which heat setting has been set (after 1 to 10 hours).

Basic settings

The appliance has various basic settings. These basic settings can be altered to suit your individual requirements.

Indicator/ symbol	Function
<i>c 1</i>	Childproof lock <i>0</i> Manual*. <i>1</i> Automatic. <i>2</i> Function deactivated.
<i>c 2</i>	Signal tones <i>0</i> Confirmation and fault signals are switched off. <i>1</i> Only the fault signal is switched on. <i>2</i> Only the confirmation signal is switched on. <i>3</i> All signal tones are switched on.*
<i>c 3</i>	Display energy consumption <i>0</i> Deactivated.* <i>1</i> Activated.
<i>c 5</i>	Automatically programming the cooking time <i>00</i> Switched off.* <i>0 1-99</i> Time until automatic switch-off.
<i>c 6</i>	Audible signal duration for the timer function <i>1</i> 10 seconds.* <i>2</i> 30 seconds. <i>3</i> 1 minute.
<i>c 7</i>	Power management function. Limiting the total power of the hob The available settings depend on the maximum power of the hob. <i>0</i> Deactivated. Maximum power of the hob. */** <i>1</i> 1000 W minimum power. <i>1.</i> 1500 W ... <i>3</i> 3000 W recommended for 13 A. <i>3.</i> 3500 W recommended for 16 A. <i>4</i> 4000 W <i>4.</i> 4500 W recommended for 20 A. ... <i>9</i> or <i>9.</i> Maximum power of the hob.**
<i>c 9</i>	Time for selecting the cooking zone <i>0</i> Unlimited: The hotplate that was last set remains selected.* <i>1</i> Limited: The cooking zone only remains selected for a few seconds.
<i>c 12</i>	Check the cookware and the cooking results <i>0</i> Not suitable <i>1</i> Not perfect <i>2</i> Suitable

c 17	Setting air recirculation mode or air extraction mode 0 Configuring air recirculation mode.* 1 Configuring air extraction mode.
c 18	Setting the automatic start 0 Switched off. 1 Switched on: The ventilation system starts at a power level in accordance with the relevant power levels for the cooking zones.*
c 20	Setting the run-on 0 Switched off. 1 Switched on*: If the hob is working in air extraction mode, the ventilation system switches itself on for approx. six minutes at power level 3 . If the hob is working in circulating-air mode, the ventilation system switches itself on for approx. 30 minutes at power level 1 . The run-on function automatically switches off after this time.
c 0	Restore to standard settings 0 Individual settings.* 1 Restore factory settings.

*Factory setting

**The hob's maximum power output is shown on the rating plate.

To access the basic settings:

The hob must be off.

1. Switch on the hob.
2. Within ten seconds, touch and hold the  symbol for approximately four seconds.
The first four displays provide product information. Touch the settings area to view the individual displays.

Product information	Display screen
After-sales service index (ASSI)	01
Production number	Fd
Production number 1	95.
Production number 2	05

3. Touching the  symbol again takes you to the basic settings.
c and **1** flash alternately on the displays and **0** appears as a presetting.

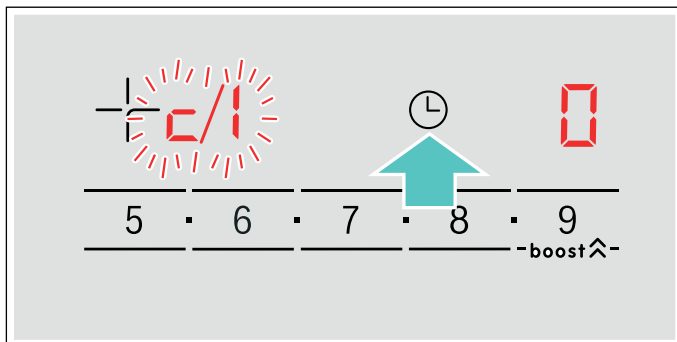

4. Touch the  symbol repeatedly until the required function is displayed.
5. Then select the required setting from the settings area.

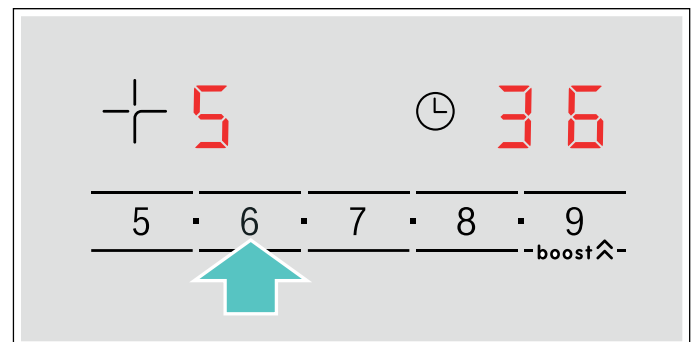

6. Touch the  symbol for at least four seconds.

The settings have been saved.

Leaving the basic settings

Turn off the hob with the main switch.

Energy consumption indicator

This function indicates the total amount of energy consumed by this hob the last time it was used for cooking.

Once the hob is switched off, the energy consumption is displayed in kilowatt hours (e.g. **1.08** kWh) for 10 seconds.

The accuracy of the information displayed depends on the voltage quality of the mains power supply, among other factors.

You can find out how to switch this function on in the section on → *"Basic settings"*

Cookware check

This function can be used to check the speed and quality of the cooking process depending on the cookware.

The result is a reference value and depends on the properties of the cookware and the hotplate being used.

1. Correctly position the pot with approximately 200 ml of water, at room temperature, on the most suitable cooking zone for the diameter of the bottom of the pot.
2. Go to the basic settings and select the setting **c 1 2**.
3. Press the programming area. **—** flashes in the cooking zone displays.

The function has now been activated.

After 10 seconds, the cooking result and the speed of the cooking process appear in the visual displays for the cooking zone.

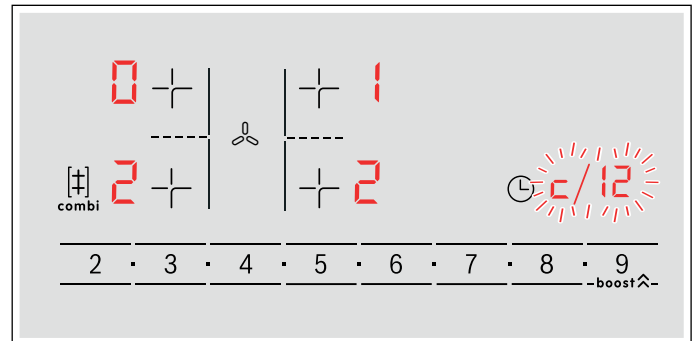

Check the result using the following table:

Result	
0	The cookware is not suitable for the hotplate and will therefore not heat up.*
1	The cookware is taking longer to heat up than expected and the cooking process is not going as well as it should.*
2	The cookware is heating up correctly and the cooking process is going well.

* If there is a smaller hotplate available, test the cookware again on the smaller hotplate.

To reactivate this function, touch the settings range.

Notes

- If the diameter of the hotplate used is much smaller than the diameter of the cookware, only the middle of the cookware can be expected to heat up. This may result in the cooking results not being as good as expected or being less than satisfactory.
- You can find information on this function in the section on → *"Basic settings"*.
- You can find information on the type, size and positioning of the cookware in the section on → *"Induction cooking"*.

Power manager

You can use the power manager to set the total power of the hob.

The hob is preset at the factory. Its maximum performance is specified on the rating plate. You can use the power manager to change the value in accordance with the requirements for the relevant electrical installation.

In order not to exceed this set value, the hob automatically distributes the power available between the cooking zones that are switched on.

As long as the power manager function is activated, the output of a cooking zone may temporarily fall below the nominal value. If a cooking zone is switched on and the power limit is reached, _ appears in the heat setting display for a short time. The appliance automatically regulates and selects the highest possible power level.

For more information about how the total power of the hob is changed, see section → *"Basic settings"*

Cleaning

Warning – Risk of burns!

The appliance becomes hot during operation. Allow the appliance to cool down before cleaning.

Warning – Risk of burns!

The appliance becomes hot during operation. If hot liquids penetrate the appliance, leave the appliance to cool before removing the metal grease filter or the overflow container.

Warning – Risk of electric shock!

Do not use any high-pressure cleaners or steam cleaners, which can result in an electric shock.

Warning – Risk of electric shock!

Penetrating moisture may result in an electric shock. Clean the appliance using a damp cloth only. Before cleaning, pull out the mains plug or switch off the circuit breaker in the fuse box.

Warning – Risk of injury!

Components inside the appliance may have sharp edges. Wear protective gloves.

Notes

- Only use a minimal amount of water when cleaning so that no water enters the appliance.
- Before cleaning, remove any jewellery from your arms and hands.
- Do not use any cleaning agents while the hob is still hot. This may mark the surface. Ensure that any residue left by cleaning agents is removed.

Cleaning agents

Only use cleaning products that are suitable for this type of hob. Follow the manufacturer's instructions on the product packaging.

Follow all instructions and warnings included with the cleaning products.

Suitable maintenance and cleaning products can be purchased from the after-sales service or in our e-Shop.

Caution!

Beware of causing surface damage

Do not use:

- Undiluted washing-up liquid
- Cleaning products designed for dishwashers
- Abrasive cleaning products
- Pressure washers or steam jet cleaners
- Oven cleaners
- Corrosive or aggressive cleaners, or those containing chlorine
- Cleaners containing a large percentage of alcohol
- Hard, scratchy sponges, brushes or scouring pads

Caution!**Beware of causing surface damage**

Always wash new sponge cloths thoroughly before use.

To ensure that the different surfaces are not damaged by using the wrong cleaning product, follow the instructions in the table.

Area	Cleaning products
Glass ceramic	<p>Glass cleaner for stains due to limescale and water marks: Clean the cooktop as soon as it has cooled down. You can use a cleaning product that is suitable for glass-ceramic hobs or glass cleaner.</p> <p>Glass scraper for stains caused by sugar, rice starch or plastic: Clean immediately. Caution: Risk of burns. Then clean with a damp dish cloth and dry with a cloth.</p> <p>Note: Do not use cleaning products designed for dishwashers.</p>
Stainless steel	<p>Hot soapy water: Clean with a dish cloth and dry with a soft cloth.</p> <p>Use a minimal amount of water when cleaning to prevent water from penetrating the appliance.</p> <p>Leave dried-on remains to soak in a small amount of soapy water; do not scour.</p> <p>Clean stainless steel surfaces in the direction of the finish only.</p> <p>Special stainless steel cleaning products are available from our after-sales service, through our online shop or from specialist retailers. Apply a very thin layer of the cleaning product with a soft cloth.</p> <p>Note: Do not use a glass scraper to clean the cooktop surround.</p>
Plastic	<p>Hot soapy water: Clean with a soft cloth or in the dishwasher.</p>
Controls	<p>Hot soapy water or an appropriate glass cleaner: Clean using a damp dish cloth and then dry with a soft cloth.</p>

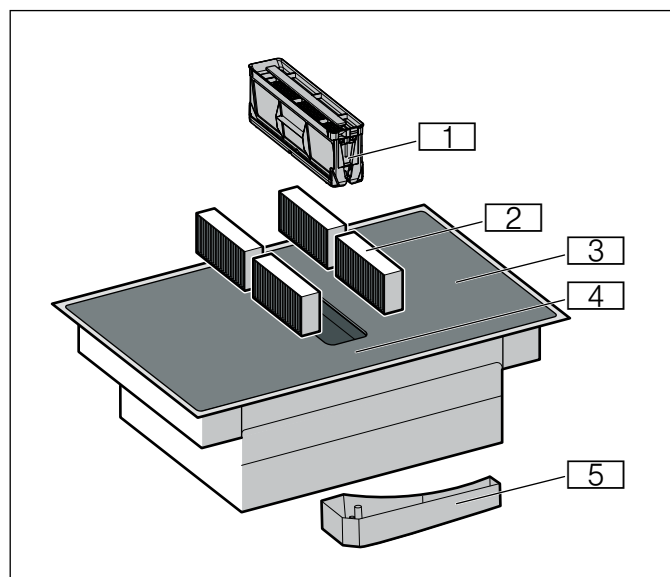
Components to clean

No.	Designation
1	Metal grease filter
2	Activated charcoal filter for air recirculation or acoustics filter for air extraction*
3	Hob
4	Control panel
5	Overflow container

*Depending on the appliance specifications

Hob surround (only on appliances with hob surrounds)

To prevent damage to the hob surround, observe the following instructions:

- Only use warm soapy water
- Wash new dish cloths thoroughly before use.
- Do not use harsh or abrasive cleaning agents.
- Do not use a glass scraper or sharp objects.
- Do not use any hard, scratchy sponges, brushes or scouring pads.

Hob

Clean the hob each time you use it. This will prevent food remnants from becoming burned on. Do not clean the hob until the residual heat indicator has gone out. Remove boiled-over liquids immediately and do not allow any food remnants to dry on.

Leave the metal grease filter in the appliance while you clean the hob. Dirt and food remnants collect in the metal grease filter and not in the appliance interior. You can clean the metal grease filter in the dishwasher.

Clean the hob with a damp dish cloth and dry it with a cloth to prevent limescale build-up.

Stubborn dirt is best removed with a glass scraper or glass ceramic cleaner (available from retailers). Follow the manufacturer's instructions.

You can obtain a suitable glass scraper (article no. 00087670) from our after-sales service or through our online shop.

Using a special sponge for cleaning glass-ceramic hobs achieves great cleaning results.

Ventilation system

The filter must be regularly cleaned or replaced in order to guarantee efficient filtration of odours and grease.

Metal grease filter

The metal grease filter must be cleaned regularly.

⚠ Warning – Risk of fire!

Fatty deposits in the grease filter may catch fire. Regularly clean the grease filter. Never operate the appliance without a grease filter.

Activated charcoal filters

The activated charcoal filter should be replaced regularly. The saturation indicator on your appliance will tell you how frequently this needs to be done.

If you only use your appliance in air extraction mode, change the acoustics filter as soon as it is dirty.

Saturation display

When the activated charcoal filters are saturated, an audible signal sounds after the appliance is switched off.

F lights up on the display.

Do not wait any longer to replace the activated charcoal filters.

If you have replaced the activated charcoal filters, you should reset the saturation indicator so that the **F** display goes out.

After the appliance has been switched off, **F** lights up.

Press and hold the symbol for the ventilation system until an audible signal sounds.

The activated charcoal filter saturation indicator has now been reset.

Changing the activated charcoal filter (only in circulating-air mode)

Activated charcoal filters trap the odour-causing compounds in cooking smells. They are only used for circulating-air mode.

Notes

- The activated charcoal filters and acoustics filters are included with the appliance. When the activated charcoal filters or acoustics filters need to be replaced, they can be obtained from specialist retailers, from our after-sales service or from our online shop.
- The activated charcoal filters and acoustics filters cannot be cleaned or reactivated.
- Only use genuine replacement filters. This will ensure that the appliance performs optimally.

1. Remove the metal grease filter.

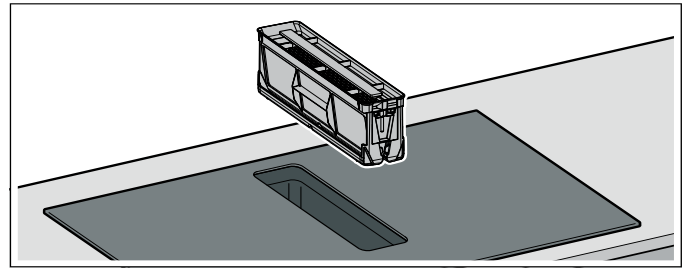

Notes

- Grease may accumulate in the bottom of the container. Hold the metal grease filter level to prevent grease from dripping out.
 - Make sure that the metal grease filter does not fall and damage the cooktop.
2. Remove the four activated charcoal filters or acoustics filters and dispose of them properly.

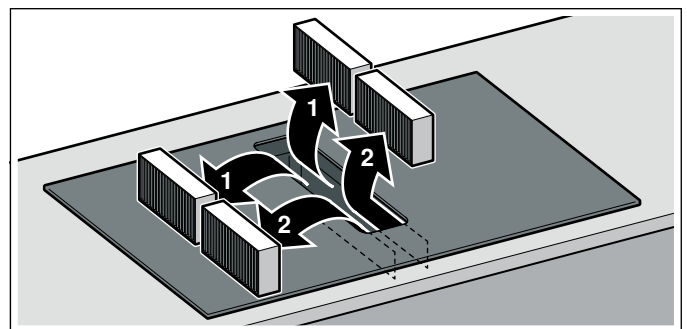

3. Insert two of the activated charcoal filters or acoustics filters into the left and right of the appliance and slide them forwards.

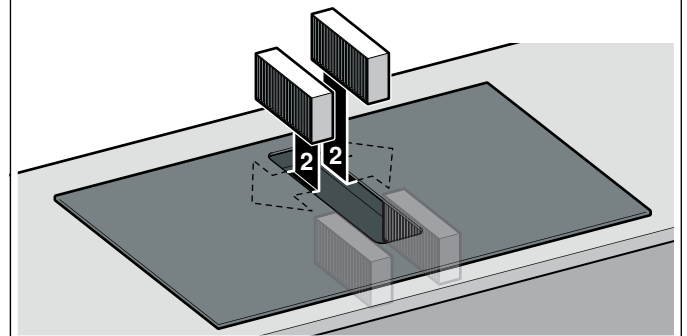
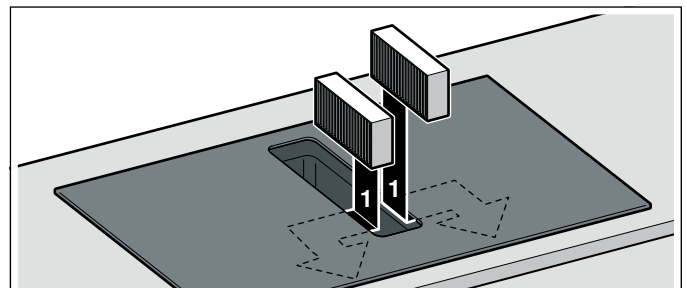

4. Insert the other activated charcoal filters or acoustics filters into the left and right of the appliance.
5. Insert the metal grease filter.

Resetting the saturation displays

If you have replaced the activated charcoal filters, you should reset the saturation indicator so that the **F** display goes out.

After the appliance has been switched off, **F** lights up.

Press and hold the symbol for the ventilation system until an audible signal sounds.

The activated charcoal filter saturation indicator has now been reset.

Removing metal grease filter

The metal grease filters filter the grease out of kitchen steam. To keep it in good working order, the metal grease filter must be cleaned regularly.

Also clean the inside of the hob extractor system regularly. You can use a special degreaser to remove stubborn dirt.

1. Remove the metal grease filter.

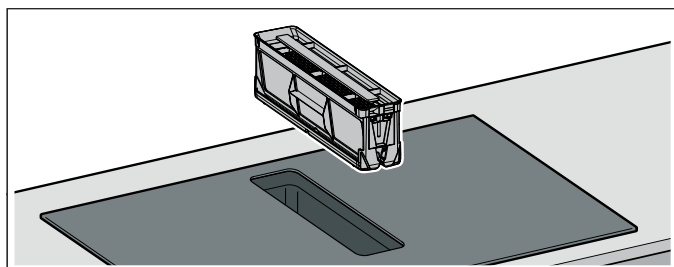

Notes

- Grease may accumulate in the bottom of the container. Hold the metal grease filter level to prevent grease from dripping out.
 - Make sure that the metal grease filter does not fall and damage the cooktop.
2. Clean the metal grease filters in the dishwasher or with hot soapy water. → "Cleaning the metal grease filter" on page 27
 3. If required, after removing the metal grease filter, remove the activated charcoal filter and clean the appliance from the inside.
 4. After cleaning, reinsert the dried metal grease filter.

Cleaning the metal grease filter

Notes

- Do not use aggressive, acidic or alkaline cleaning products.
- The metal grease filter can be cleaned in the dishwasher or by hand.

By hand:

Note: You can use a special degreaser to remove stubborn dirt. It can be ordered via the online shop.

- Remove the metal grease filter.

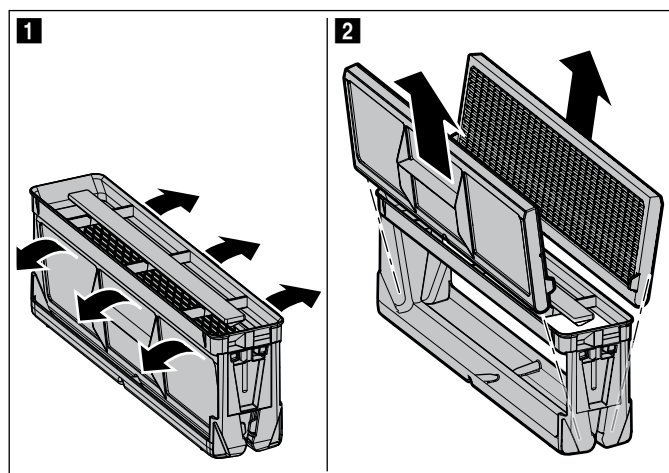

- Soak the metal grease filter in hot soapy water.
- Clean the metal grease filter with a brush and then rinse it thoroughly.
- Leave the metal grease filter to drain.

In the dishwasher:

- Do not clean the metal grease filter together with cookware if heavily soiled.
- Place the metal grease filter in the dishwasher, leaving plenty of space around it. Do not trap the metal grease filter.
- For best results, place the metal grease filter in the dishwasher filter side down.

Cleaning the overflow container

1. Unscrew the overflow container with both hands.
Note: Hold the overflow container level to prevent liquid from leaking out.

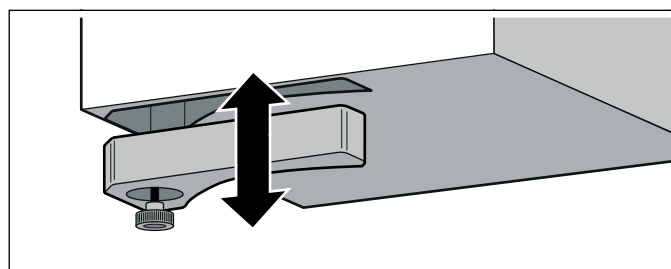

2. Empty the overflow container and rinse it out.
3. If necessary, unscrew the screw and clean the overflow container without the screw in the dishwasher.
4. Clean the overflow container before screwing it back into place.

Notes

- Ensure that the supply to the overflow container is not blocked. Once it has cooled down, remove any objects that have entered the appliance. To do this, remove the metal grease filter.
- If liquid gets into the appliance from above, this is collected in the overflow container. Unscrew the overflow container and empty it.

Frequently Asked Questions (FAQ)

Using the appliance

Why can I not switch on the hob and why is the childproof lock symbol lit?

The childproof lock is now active.

You can find information about this function in the section → "*Childproof lock*".

Why are the illuminated displays flashing and why is a signal sounding?

Remove any liquid or remnants of food from the control panel. Remove any objects from the control panel.

You can find out how to deactivate the audible signal in section → "*Basic settings*".

The ventilation system does not switch on even though the automatic start is set.

Switch on the ventilation system manually or check the configuration of the automatic mode. You can find additional information about this in section → "*Basic settings*".

The ventilation system remains on even though the cooking zones have been switched off.

Manually switch off the ventilation system.

You can find additional information about this setting in section → "*Operating the appliance*".

The air intake is too weak.

Ensure that the metal grease filter is clean.

You can find additional information about changing the filter and cleaning in section → "*Cleaning*".

Noises

Why I can hear noises while I'm cooking?

Noises may be generated while using the hob depending on the base material of the cookware. These noises are a normal part of induction technology. They do not indicate a defect.

Possible noises:

A low humming noise like the one a transformer makes:

Occurs when cooking at a high heat setting. The noise disappears or becomes quieter when the heat setting is reduced.

Low whistling noise:

Occurs when the cookware is empty. This noise disappears when water or food is added to the cookware.

Crackling:

Occurs when using cookware made from different layers of material or when using cookware of different sizes and different materials at the same time. The loudness of the noise can vary depending on the quantity of food being cooked or the cooking method.

High-pitched whistling noises:

Can occur when two hotplates are used at the highest heat setting at the same time. The whistling noises disappear or become quieter when the heat setting is reduced.

Fan noise:

The hob is equipped with a fan that switches on automatically at high temperatures. The fan may continue to run even after you have switched off the hob if the temperature detected is still too high.

Cookware

Which types of cookware can be used with an induction hob?

You can find information on which types of cookware can be used with an induction hob in the section on → *"Induction cooking"*

Why is the hotplate not heating up and why is the heat setting flashing?

The hotplate on which the cookware is standing is not switched on.
Check that you have switched on the correct hotplate.

The cookware is too small for the hotplate that is switched on or it is not suitable for induction cooking.
Check that the cookware is suitable for induction cooking and that it is placed on the hotplate that best corresponds to its size. You can find information on the type, size and positioning of the cookware in the sections on → *"Induction cooking"*, → *"CombiZone function"* and → *"Move function"*

Why is it taking so long for the cookware to heat up or why is it not heating up sufficiently despite being on a high heat setting?

The cookware is too small for the hotplate that is switched on or it is not suitable for induction cooking.
Check that the cookware is suitable for induction cooking and that it is placed on the hotplate that best corresponds to its size. You can find information on the type, size and positioning of the cookware in the sections on → *"Induction cooking"*, → *"CombiZone function"* and → *"Move function"*

Cleaning

How do I clean the induction hob?

Optimal results can be achieved with cleaning products specifically for use on glass-ceramic surfaces. Do not use harsh or abrasive cleaning products, dishwasher detergents (concentrates) or floor cloths.
To find out how to clean and care for the hob, refer to the section entitled → *"Cleaning"*.

There is water in the cabinet underneath the hob.

Check whether the overflow container is full.
To find out how to clean the overflow container, refer to the section entitled → *"Cleaning"*.

How often do I need to clean the overflow container?

Clean the overflow container frequently.
To find out how to clean the overflow container, refer to the section entitled → *"Cleaning"*.

How often do I need to clean the metal grease filter?

Clean the metal grease filter regularly.
To find out how to clean and care for the filter, refer to the section entitled → *"Cleaning"*.

Trouble shooting

Usually, faults are small matters that are easy to eliminate. Please read the information in the table before calling the after-sales service.

Display	Possible cause	Solution
None	The power supply has been disconnected. The appliance has not been connected as shown in the circuit diagram. Electronics fault.	Use other electrical appliances to check whether a short circuit has occurred in the power supply. Ensure that the appliance has been connected as shown in the circuit diagram. If you are unable to rectify the fault, inform the technical after-sales service.
The displays flash.	The control panel is damp or there is something on it.	Dry the control panel or remove the object.
The  display flashes in the cooking zone displays.	A fault has occurred in the electronics.	To acknowledge the fault, briefly cover the control panel with your hand.
F	The active carbon filter is saturated or the saturation indicator lights up even though the filter has been cleaned or replaced.	Change the filter and reset the filter saturation indicator. You can find additional information about this in section → "Cleaning".
F2	The electronics have overheated and have switched off the affected cooking zone.	Wait until the electronics have cooled down sufficiently. Then touch any symbol on the hob.
F4	The electronics have overheated and all of the cooking zones have been switched off.	
F5 + power level and audible signal	There is hot cookware near the control panel. There is a risk that the electronics will overheat.	Remove the cookware that is causing the problem. The fault display goes out shortly afterwards. You can continue cooking.
F5 and audible signal	There is hot cookware near the control panel. The cooking zone has been switched off to protect the electronics.	Remove the cookware that is causing the problem. Wait a few seconds. Touch any touch control. When the fault indicator goes out, you can continue cooking.
F1/F6	The cooking zone has overheated and has been switched off to protect the work surface.	Wait until the electronics have cooled down sufficiently. Then switch the cooking zone on again.
F8	The cooking zone has been operating continuously for an extended period.	The automatic safety cut-out function has been activated. You can find additional information about this in section .
E9000 E90 10	The operating voltage is incorrect and outside of the normal operating range.	Contact your electricity supplier.
U400	The hob is not connected correctly.	Disconnect the hob from the mains. Ensure that the hob has been connected as shown in the circuit diagram.

Do not place hot cookware on the control panel.

Notes

- If **E** appears on the display, press and hold the button for the relevant cooking zone in order to read the fault code.
- If the fault code is not listed in the table, disconnect the hob from the mains power supply and wait 30 seconds before reconnecting it. If this code is displayed again, contact the technical after-sales service and specify which fault code has appeared.
- If a fault occurs, the appliance will not switch to standby mode.

Customer service

Our after-sales service is there for you if your appliance needs to be repaired. We will always find an appropriate solution, also in order to avoid after-sales personnel having to make unnecessary visits.

Product number (E no.) and production number (FD no.)

When contacting our after-sales service, always quote the product number (E no.) and the production number (FD no.) of the appliance.

The rating plate bearing these numbers can be found:

- On the appliance certificate.
- On the front underside of the hob.

The product number (E no.) can be found on the glass-ceramic hob. You can see the after-sales service index (KI) and production number (FD no.) by going to the basic settings. See section → *"Basic settings"*.

Please note that a visit from an after-sales service engineer is not free of charge in the event that the appliance has been misused, even during the warranty period.

Please find the contact data of all countries in the enclosed customer service list.

To book an engineer visit and product advice

GB 0344 892 8979

Calls charged at local or mobile rate.

IE 01450 2655

0.03 € per minute at peak. Off peak 0.0088 € per minute.

Rely on the professionalism of the manufacturer. You can therefore be sure that the repair is carried out by trained service technicians who carry original spare parts for your appliances.

Test dishes

This table has been produced for test institutes to facilitate the testing of our appliances.

The data in the table refers to our Schulte-Ufer cookware accessories (4 piece cookware set for the HEZ 390042 induction hob) with the following measurements:

- Saucepan Ø 16 cm, 1.2 l for hotplates of Ø 14.5 cm
- Pot Ø 16 cm, 1.7 l for hotplates of Ø 14.5 cm
- Pot Ø 22 cm, 4.2 l for hotplates of Ø 18 cm
- Frying pan Ø 24 cm, for hotplates of Ø 18 cm

Test dishes	Cookware	Heat setting	Preheating		Cooking	
			Cooking time (min:sec)	Lid	Heat setting	Lid
Melting chocolate Chocolate coating (e.g. Dr. Oetker brand, dark chocolate 55% cocoa, 150 g)	Saucepan, 16 cm diameter	-	-	-	1.	No
Heating and keeping lentil stew warm Lentil stew* Initial temperature 20 °C						
Amount: 450 g	Cooking pot, 16 cm diameter	9	1:30 (without stirring)	Yes	1.	Yes
Amount: 800 g	Saucepan, 22 cm diameter	9	2:30 (without stirring)	Yes	1.	Yes
Lentil stew from a tin E.g lentils with Erasco sausages. Initial temperature 20 °C						
Amount: 500 g	Cooking pot, 16 cm diameter	9	Approx. 1:30 (stir after approx. 1 minute)	Yes	1.	Yes
Amount: 1 kg	Saucepan, 22 cm diameter	9	Approx. 2:30 (stir after approx. 1 minute)	Yes	1.	Yes
Preparing Béchamel sauce Temperature of the milk: 7 °C Ingredients: 40 g butter, 40 g flour, 0.5 l milk (3.5% fat content) and a pinch of salt						
1. Melt the butter, stir in the flour and salt, and heat up the mixture.	Saucepan, 16 cm diameter	2	Approx. 6:00	No	-	-
2 Add the milk to the roux and bring to the boil, stirring continuously.		7	Approx. 6:30	No	-	-
3. Once the Béchamel sauce comes to the boil, leave it on the hotplate for a further two minutes, stirring continuously.		-	-	-	2	No

*Recipe in accordance with DIN 44550

**Recipe in accordance with DIN EN 60350-2

Test dishes	Cookware	Heat setting	Preheating		Cooking	
			Cooking time (min:sec)	Lid	Heat setting	Lid
Cooking rice pudding						
Rice pudding, cooked with the lid on Temperature of the milk: 7 °C Heat the milk until it starts to rise up. Set the recommended heat setting and add rice, sugar and salt to the milk. The cooking time, including preheating, is approx. 45 minutes.						
Ingredients: 190 g short-grain rice, 90 g sugar, 750 ml milk (3.5% fat content) and 1 g salt	Cooking pot, 16 cm diameter	8.	Approx. 5:30	No	3 (stir after 10 minutes)	Yes
Ingredients: 250 g short-grain rice, 120 g sugar, 1 l milk (3.5% fat content) and 1.5 g salt	Saucepan, 22 cm diameter	8.	Approx. 5:30	No	3 (stir after 10 minutes)	Yes
Rice pudding, cooked without lid Temperature of the milk: 7 °C Add the ingredients to the milk and heat the mixture up while stirring continuously. Once the milk has reached approx. 90 °C, select the recommended heat setting and leave it to simmer on a low heat for approx. 50 minutes.						
Ingredients: 190 g short-grain rice, 90 g sugar, 750 ml milk (3.5% fat content) and 1 g salt	Cooking pot, 16 cm diameter	8.	Approx. 5:30	No	3	No
Ingredients: 250 g short-grain rice, 120 g sugar, 1 l milk (3.5% fat content) and 1.5 g salt	Saucepan, 22 cm diameter	8.	Approx. 5:30	No	2.	No
Cooking rice*						
Water temperature: 20 °C						
Ingredients: 125 g long grain rice, 300 g water and a pinch of salt	Cooking pot, 16 cm diameter	9	Approx. 2:30	Yes	2	Yes
Ingredients: 250 g long grain rice, 600 g water and a pinch of salt	Saucepan, 22 cm diameter	9	Approx. 2:30	Yes	2.	Yes
Roasting a pork loin						
Initial temperature of the loin: 7 °C						
Amount: 3 pork loins (total weight approx. 300 g, 1 cm thick) and 15 ml sunflower oil	Frying pan, 24 cm diameter	9	Approx. 1:30	No	7	No
Preparing pancakes**						
Amount: 55 ml batter for each pancake	Frying pan, 24 cm diameter	9	Approx. 1:30	No	7	No
Deep-fat frying chips						
Amount: 2 l sunflower oil, per portion: 200 g frozen chips (e.g. McCain 123 Original fries)	Saucepan, 22 cm diameter	9	Until the oil temperature reaches 180 °C	No	9	No

*Recipe in accordance with DIN 44550

**Recipe in accordance with DIN EN 60350-2



Thank you for buying a Bosch Home Appliance!

Register your new device on MyBosch now and profit directly from:

- **Expert tips & tricks for your appliance**
- **Warranty extension options**
- **Discounts for accessories & spare-parts**
- **Digital manual and all appliance data at hand**
- **Easy access to Bosch Home Appliances Service**

Free and easy registration – also on mobile phones:

www.bosch-home.com/welcome



Looking for help? You 'll find it here.

Expert advice for your Bosch home appliances, need help with problems or a repair from Bosch experts.

Find out everything about the many ways Bosch can support you:

www.bosch-home.com/service

Contact data of all countries are listed in the attached service directory.

Robert Bosch Hausgeräte GmbH

Carl-Wery-Straße 34

81739 München

Germany

www.bosch-home.com



9001469459

000120(01)